

TP-100 stipite alluminio

parete divisoria - partition wall aluminium frame
Alu-Zargen für Trennwand

Stipite in alluminio per parete divisoria House office con possibilità di montaggio a muro con sopra-luce o con vetri fissi laterali.

Aluminium Frame for partition walls House office with possible installation on the wall or with side panels or overpanel.

Aluminiumzargen für Trennwand Programm House office mit Wandbefestigung oder mit Seitenteilen und Oberlichte.



stipite alluminio TP-100

SEZIONI VERTICALI PORTE BATTENTI- Partition vertical section frame - Vertikalschnitt Trennwand Rahmenprofil

Sezione verticale porta battente a soffitto
Vertical section ceiling-mounted hinged door
Vertikalschnitt Tür mit Deckenbefestigung

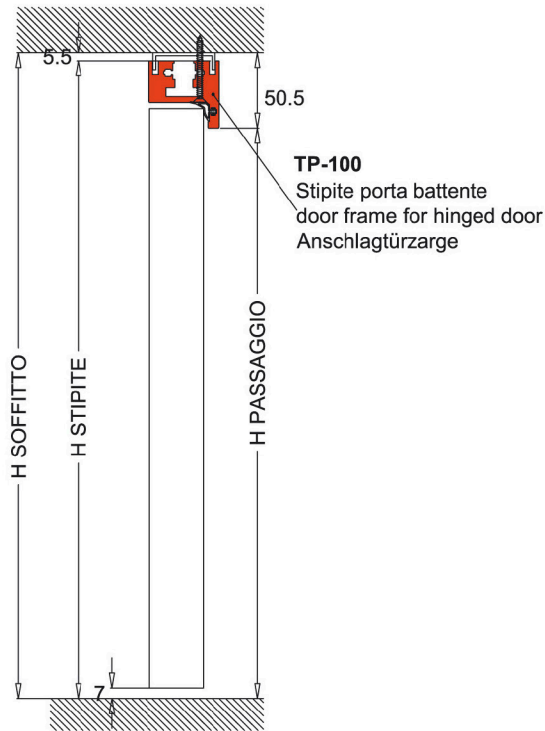

Sezione verticale porta battente con sopra luce
Vertical section hinged door with overpanel
Vertikalschnitt Tür mit Oberlicht

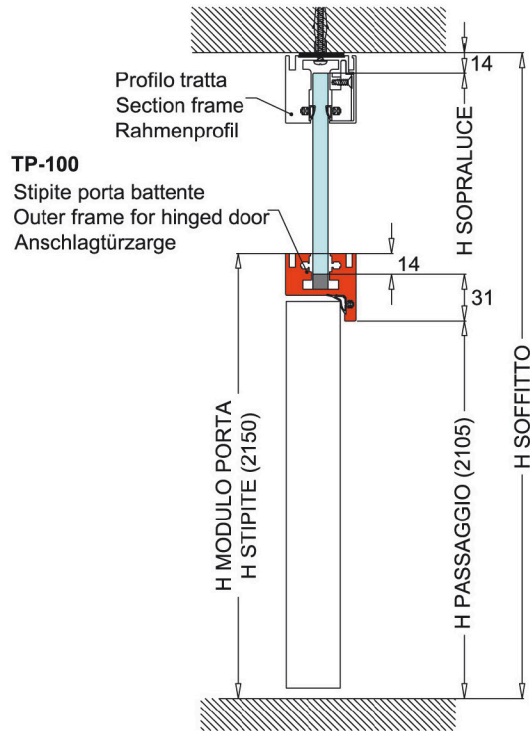

TIPOLOGIE PORTE BATTENTI - Hinged doors - Drehtüren

Telaio porta battente
Door panel surround
Flügelrahmen

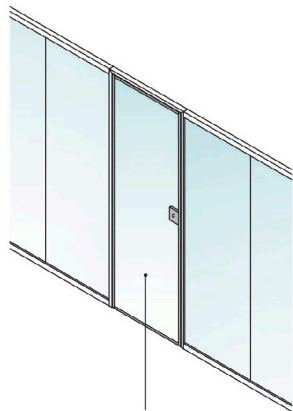

Art.PO-100

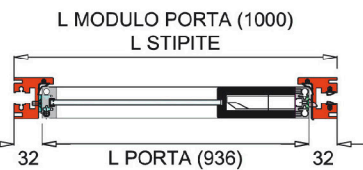

Porta battente vetro con cerniere V-509
Glass door with hinges V-509
Glastür mit Bänder V-509

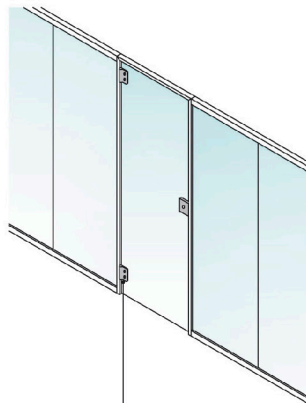

Art.PO-150

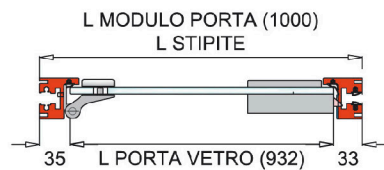

Porta battente vetro con cerniere automatiche V-508
Glass door with automatic hinges V-508
Glastür automatische mit Bänder V-508

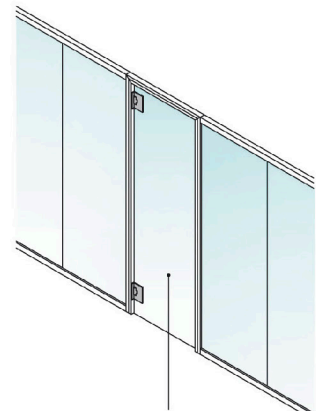

Art.PO-160



H soffitto
Clear opening height
Lichte Durchgangsh

H parete
Partition height
Rahmenaußenmaß - Höhe

H passaggio
Door nett height passage
Tür - Lichtes β - Höhe

H modulo porta
Module door height
Türmodul Höhe

H sopra luce
Overpanel height
Oberlicht Höhe

L modulo porta
Module door width
Türmodul Breite

L stipite
Door frame width
Zargenaußenmaß - Breite

L porta
Door width
Tür - Breite

stipite alluminio TP-100

caratteristiche profilo tratta - partition walls section - Trennwand die Profile

Art.VP-130

staffa di collegamento verticale per profili parete
Vertical connecting bracket for partition frames
Vertikale Verbindungsstange für Wandprofile

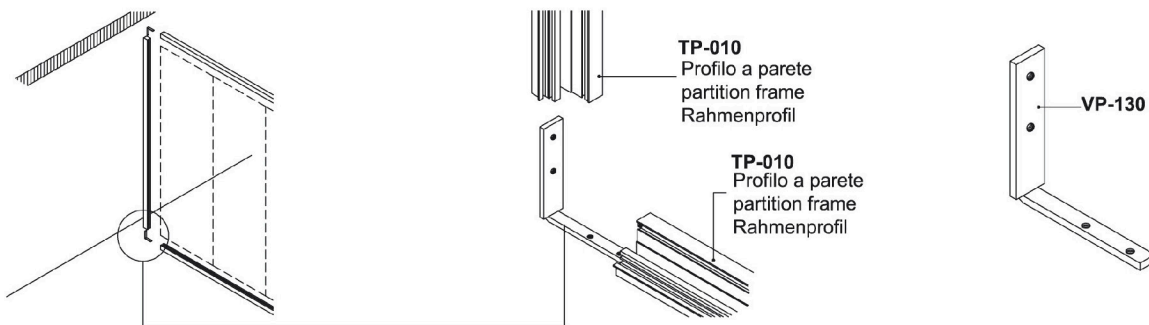

Art.TP-100

stipite porta battente
door frame for hinged doors
Anschlagtürzarge

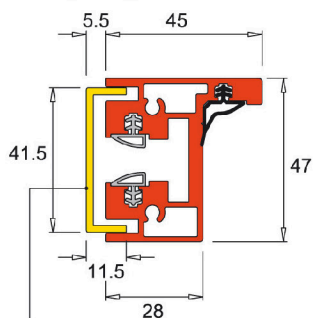

Art.P-033

profilo a muro
Wall frame
Wandprofil

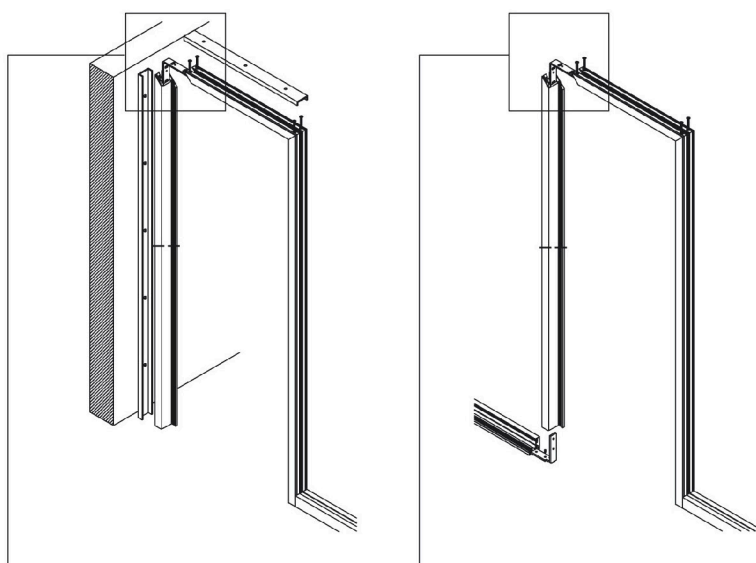

Profilo a muro per attacco a soffitto
Wall frame for attaching to ceiling
Wandprofil mit Deckenbefestigung

Art.VP-150

Staffa collegamento stipiti
Door frame connecting bracket
Stange zum Verbinden der Türzarge

Profilo a muro con
partenza/arrivo porta battente
Wall frame with hinged door start/end
Wandprofil mit Ausgang/Ende
Flügeltüre

Profilo stipite
door frame profile
Türzargenprofil

Guarnizione di battuta porta
Gasket
Dichtung

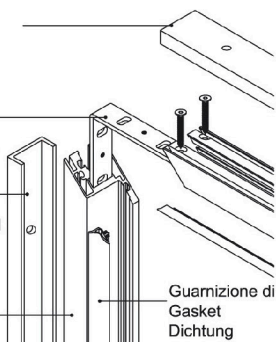

Guarnizione vetro
Glass gasket
Dichtung

Art.VP-150

Staffa collegamento stipiti
Door frame connecting bracket
Stange zum Verbinden
der Türzarge

Profilo stipite
door frame profile
Türzargenprofil

Guarnizione di battuta porta
Gasket
Dichtung

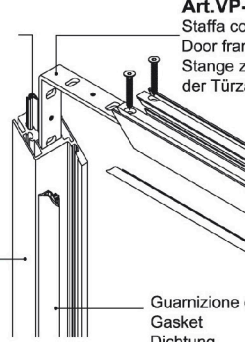

Art.VP-140

staffa di collegamento profilo parete e stipite porta battente
Bracket for connecting partition frame and door frame
Verbindungsstange Rahmenprofil und Türpfosten der Flügeltüre

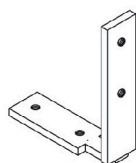

TP-010
Profilo a parete
partition frame
Rahmenprofil

TP-100
Stipite
door frame profile
Türzarge

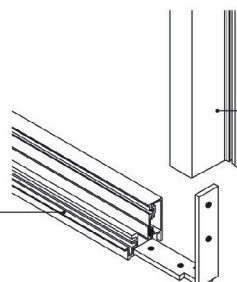



house office



■
Particolare giunto a tre vie
Detail three - way joints
Detail 3 - Wegeverbindungen



■
Particolare stipite battente
Detail door frame for hinged doors
Detail Anschlagtürzarge



■
Maniglia art. V-1561-S
Handle art. V-1561-S
Türgriff art. V-1561-S

